



magazine

Where Innovation is Tradition

October 2012



Report
Scoring with
Top Quality



■ **Innovations**
Built to Resist

■ **Portrait**
French Connection

■ **Special topic**
Oxygen: Tackling a
Burning Issue

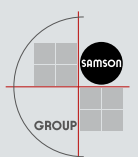

Contents



Title
Edmonton, the oil capital of Canada, is home to the Edmonton Oilers playing in the North American National Hockey League (NHL)

Imprint

SAMSON magazine Issue 16

Publisher:
SAMSON AKTIENGESELLSCHAFT
Weismüllerstraße 3 · 60314 Frankfurt am Main · Germany
Phone: +49 69 4009-0 · Internet: www.samson.de

Graphic design and editing:
Public Relations and Technical Documentation Department

Text:
Zsolt Pekker

Photos:
SAMSON AG
Air Liquide (p. 15)
SMS Siemag (p. 30)

Printed by:
Hinckel-Druck GmbH

The texts and photos in this magazine may not be reproduced, distributed, displayed or published without the prior written approval of SAMSON AKTIENGESELLSCHAFT, Frankfurt am Main.

© 2012 SAMSON AKTIENGESELLSCHAFT

3

Editorial

New Markets Giving Rise to New Demands

4

Innovations

Built to Resist

8

Portrait

French Connection

16

Report

Scoring with Top Quality
Prompt Support for Customers in Africa

24

Impulse

Unity Through Design

28

Special topic

Oxygen: Tackling a Burning Issue

32

Spotlight

A Rewarding Year



New Markets Giving Rise to New Demands

Dear Readers,

SAMSON's first subsidiary abroad was opened in England in 1958. Four years later, the second subsidiary followed in France. This year, the French subsidiary is celebrating its 50th anniversary. To mark this event, you will find a detailed report on our French subsidiary in this magazine edition. Presently, SAMSON has 40 sales companies and five production sites in various countries all around the globe.

Since initially starting business in Europe, the magnitude and nature of our international business has changed dramatically. These days, the SAMSON GROUP generates 40 % of its revenue outside the European Union. Export has become a mainstay for the entire group. But it is not just the sales volume that makes international business worthwhile. New markets have also given rise to new demands and spurred us to develop new products. For instance, the demand for aseptic valves and our response to it first originated in France. Another example is the valve with clamped-in seat that we developed in response to the requirements of natural gas production in the (sub)arctic regions of Siberia and North America. Many more examples could be listed.

Extending the product range also entails new test procedures as well as adapting corporate processes and structures to match the different markets. One example for this is the efficient after-sales service structure set

up for our customers in southern Africa, a topic also covered in this magazine. The work performed in our service and test center in Cape Town is a good illustration of how our business not only involves the products themselves. Just as important as the engineering side is the communication with our customers. We constantly endeavor to bridge cultural differences. This works exceptionally well when we accept these differences and take them as enriching experiences that we can learn from. Even with all the different means of modern communication available these days, in the end it all comes down to the people involved. Personal contact remains a key factor for success.

I hope you enjoy reading our new SAMSON magazine.

Michael Kiener
Head of International Sales

BUILT to Resist

Bunker silos to store the corn produced on the gigantic farms used to be the traditional landmarks dotting the wide North Dakota plains. Since the end of the 1950s, however, more and more oil rigs have popped up in the seemingly endless expanses of the Great Plains state in the northern United States. In 1951, prospecting teams dispatched by the Hess Corporation, now the largest gas producer and third largest oil producer in North Dakota, discovered the Bakken shale play, which holds large reserves of oil and gas. Initially, the

gas was mostly flared. Nowadays, it is captured and used extensively. It is not far from the place where the first fossil treasures were discovered that the provincial town of Tioga is located. Here in western North Dakota, Hess operates a gas processing plant that is currently undergoing expansion. As part of this expansion, the plant operator opted to install the new Type 3291 Valves by SAMSON as they are particularly easy to service and operate reliably even at very low temperatures.



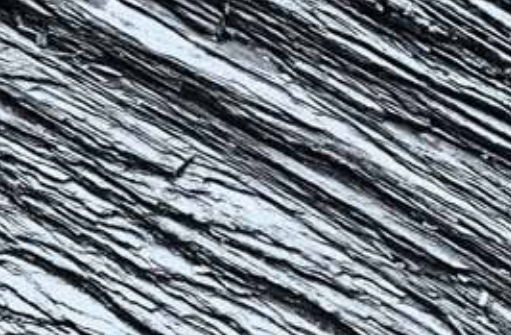

Shale gas and its impurities

Like crude oil, natural gas is a mixture of numerous substances, with methane accounting for the largest share (75 to 99 %). Depending on the reservoir's location, the recovered natural gas can contain further compounds similar to methane, such as ethane, butane or propane. It is these hydrocarbon gases that are used for energy generation or further chemical processing. But before they can be put to use, varying contents of unwanted impurities, such as steam, hydrogen sulfide, nitrogen or oil residue, need to be removed.

In ideal gas reservoirs, as encountered in Russia for example, the natural gas occurs in subterranean bubbles with a very high degree of purity. In the Bakken field, however, the gas is found as shale gas trapped in the oil-containing layers of rock. The gas needs to be dissolved from the rock, also the reason why it contains a lot of sulfur and carbon dioxide. At Tioga, such substances are removed and the remaining gas is transformed into NGLs (Natural Gas Liquids). The plant produces the major share of propane consumed in the region directly at the extraction site. Currently, Hess is implementing an expansion of the Tioga gas plant to increase the daily inlet gas capacity from 120 to 250 MMscfd, i.e. from 3 to 7 million m³.

Bunker silos to store the enormous amounts of corn produced on the gigantic farms are traditional landmarks dotting the North Dakota landscape

Competence in cryogenics

While high temperatures are needed to refine crude oil, some steps in the gas fractionation process occur at extremely low temperatures. In this field, cryogenic procedures at temperatures below -150 °C have proven to be most efficient. The different gases are cooled to temperatures below their boiling point, at which they liquefy and can be separated from each other.

At -161.7 °C, methane has the lowest boiling point of the hydrogen gases involved. This is why the equipment installed in the Tioga plant needs to function reliably and without any problems even at extremely low temperatures.

Such temperatures really put the materials to the test as the cold even makes many metals go brittle. For valves, whose moving trim parts are exposed to the cryogenic medium, this means that only special alloys of the highest quality and special technical solutions can be employed. "Hess had experienced problems in exactly this area with valves from a different manufacturer," states Mr. Abraham John, head of SAMSON Project Engineering Inc. The company operates out of Houston, Texas, and assists its customers in oil and gas projects across the world. According to Mr. John, there was no other valve manufacturer with as much experience and expertise in cryogenic applications

as SAMSON: “We have been cooperating closely with the producers of technical gases for decades. This is why we know exactly what the requirements in this field are and can provide the right technical solutions.” He adds that SAMSON’s know-how and experience also were the decisive factors in winning over the engineers in charge of the Tioga expansion.

Decisive design advantage

For the plant expansion, Hess decided in favor of the new Type 3291 Valves, which control the pressure, temperature and flow rate of gases in the new liquefaction process to Hess’s full satisfaction. The valves were specifically developed for application in the oil and gas industry. Their construction is based on the proven SAMSON valve design, with one significant difference: while the seats in SAMSON valves are normally screwed in place, the new

valve type has a clamped-in seat to hold the plug. The main benefit of this design is that valve maintenance is much easier, which is particularly important in oil and gas applications. Mr. John explains why: “Chemical plants are completely shut down at regular intervals for maintenance routines. The plants working directly at the oil and gas extraction sites, however, are not. They operate non-stop in most cases. And if a valve fails, its repair must be quick and easy.”

The Type 3291 Valve was tailored to the specific requirements of the oil and gas industry

The first rigs of the Bakken shale play popped up in the wide North Dakota plains during the 1950s. The field holds shale gas trapped in the oil-containing layers of rock





Type 3291 Valve

The valve was specifically developed for application in the oil and gas industry. Its construction is based on the proven SAMSON valve design, but instead of being screwed in place, the valve's seat is clamped in. Contrary to the widespread cage valves, the SAMSON valve generates very little friction during operation and is resistant to dirt deposits and leakage.

- Clamped-in seat
- No special tools required for maintenance
- Proven design
- Minimized wear at the seat and plug
- High resistance to dirt deposits and leakage
- For temperatures from -198 to 450 °C
- Particularly suitable for applications where crevice corrosion is expected to occur between the seat and body

Quick and easy maintenance

Valve seats are subject to natural wear, particularly under the severe conditions that exist in gas processing. As a result, ease of maintenance is a competitive edge. The seat of the Type 3291 can be installed and removed fast. The only tool required is the standard seat tool always available in such plants. Compared to the valves with cages that are still widely used in the industry, the SAMSON valve has another decisive advantage that Mr. John describes as follows: "When the valve is depressurized, a cage is highly susceptible to dirt penetra-

tion. In addition, the piston-shaped plug is stroked inside the cage over a considerable distance. Both factors favor the generation of score marks, cracks and leakage." The design of the Type 3291 largely excludes such negative effects. Moreover, the new SAMSON valve generates considerably less friction during operation than a cage valve, which reduces the natural wear, significantly prolongs the valve's service life and extends the service interval.

50

FRENCH

Connection



The French concept of *savoir vivre* encompasses living the good life and knowing how to get the most from it. The amazing variety of landscapes and climates from the north of the country to the Mediterranean sea reflects the diversity of France, which produces the finest culinary treats. *Haute cuisine*, the world-renowned high art of French cooking, could only have emerged from here. Nevertheless, it constitutes only for a small part of the infinitely rich culture of this nation, which has inspired people in Europe and the rest of the world. France is not just the most important partner for Germany within the European Union in political and economic terms. Close ties and an intensive exchange between the two nations characterize the life at SAMSON, too. The French subsidiary is the largest business unit within the SAMSON GROUP after the headquarters in Frankfurt. This year, the subsidiary celebrates its 50th anniversary.

Hermann, Wilhelm and Ernst Sandvoss
in Paris in 1895

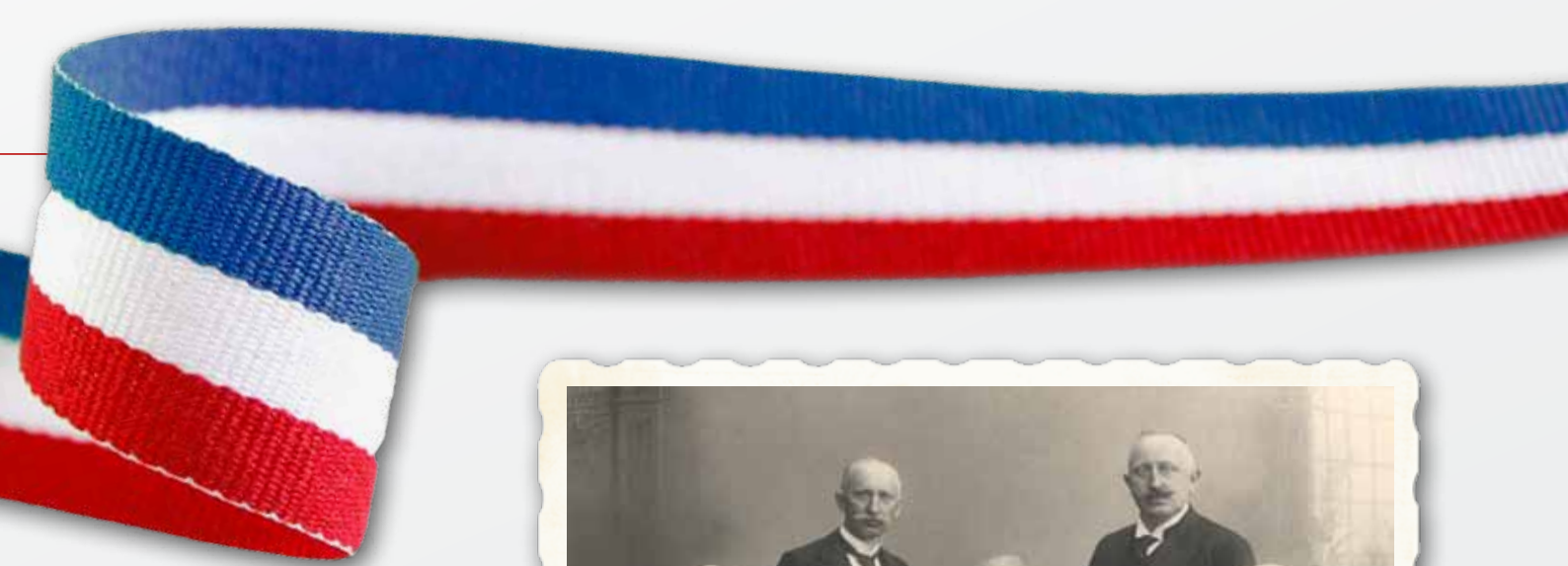

Sharing Celtic, Germanic and Roman roots, the Frankish Empire emerged in the early Middle Ages and grew to become the largest empire in Europe since the downfall of the Roman Empire. Both the French and Germans trace back their national history to the Empire's greatest ruler: Charles the Great, better known as Charlemagne. Under his rule, the empire stretched from Brittany in the west to the Oder River in the east and from the Baltic Sea in the north to the Pyrenees in the south. After his death, Charlemagne's heirs were unable to keep the enormous realm united. After it had fallen apart, the Kingdom of France emerged during the course of the following centuries, covering an area roughly corresponding to modern-day France.

Cultural attraction

From this time on, France played a decisive role in European history as a central power and developed into a major cultural nation in modern times. For centuries, Paris has enjoyed a reputation as the capital of art and culture in the Western world. The ideas of freedom, equality and democracy started their



The Sandvoss brothers (Heinrich, Wilhelm, Ernst, Hermann and Carl Sandvoss) taken on the occasion of a family get-together in 1905

global conquest from this very city. French scholars made a decisive contribution to the advancement of natural sciences.

It was not surprising that Wilhelm Sandvoss was attracted by France in his younger years. The co-founder of SAMSON came from a poor background. His father was unable to finance a university education, neither for him nor for any of his four brothers. Yet, the ambitious young man made a choice that would shape his future when he decided to begin a millwright apprenticeship in the 1880s. At that time, the increasingly efficient use of steam engines placed mills at the forefront of technology. As was tradition in those days for a new-fledged fellow, Wilhelm Sandvoss left home after completing his apprenticeship to gain experience

in his profession in faraway places. He spent the majority of his years of travel in France where he came to appreciate the country, its people and, naturally, the cuisine.

Early contacts

After the foundation of SAMSON in 1907, Wilhelm Sandvoss used his contacts from the millwright business to export SAMSON products to his former host country. In this way, France became the first foreign market for the young company and the Francophile attitude and close ties with the country became part of the corporate tradition. Hermann Sandvoss, Wilhelm's brother and managing director of SAMSON, also diligently cultivated business contacts to Germany's western neighbor, as his successors have

done ever since. The two world wars, during which Germany and France faced each other as bitter enemies, did not do much to promote business relationships between the two countries. Yet, they never broke off completely, even under the most adverse circumstances.

New friendships even grew out of the enforced hostility: the injured German soldier Herbert Feistner stayed behind in Chamonix after the German troops withdrew in 1945 and after convalescence, he was assigned to forced labor as a prisoner of war. During this time, he not only met his wife-to-be, he also ran into the business man Jean Falconnier, who maintained long-established business contacts to the Sandvoss brothers. 17 years later, Herbert Feistner and Jean Falconnier founded SAMSON Régulation S.A. in Villeurbanne, a suburb of

Lyon. Mr. Falconnier became the company's first managing director. After he retired a few years later, Herbert Feistner took over the position as *président-directeur général*.

At the center of it all

After SAMSON's first subsidiary was founded in the UK, the second subsidiary in France followed. The metropolitan area of Lyon—the location chosen by Herbert Feistner and Jean Falconnier—proved to be the right choice. Refineries and major chemical and pharmaceutical companies had also established themselves in this area. Lyon, dubbed “la ville de gueule” - gourmet town, is surrounded by a region well-known for its unique variety of culinary

products acclaimed worldwide. Numerous first-rate food and beverage manufacturers are located around the city. Culinary highlights include poultry from Bresse, fish from the local rivers and lakes, fruit growing on the Monts du Lyonnais and in the Rhône valley, vegetables cultivated on the plains of the Ain department and cheese originating from Dauphiné and the Ardèche regions. Of course, not forgetting the wine from the world-famous vineyards of Côtes du Rhône, Beaujolais, Bugey and Burgundy as well as the numerous famous sources of natural mineral water including Evian.

Rudolf Maier, the CEO of SAMSON's subsidiary in France, remarks: “The market tells us what it wants and we make sure that it gets it.” Mr. Maier, a German national, is the third *président-directeur général* in succession after Herbert Feistner. Similar to his predecessor, he is also married to a French woman and feels completely at home away from home. “To be able to supply our customers more quickly, we already started to set up our own produc-



SAMSON Régulation S.A. located in the Lyon suburb of Villeurbanne in the 1960s



The team at SAMSON Régulation S.A. in the 1980s

tion facilities in the 1970s. Since the food processing industry requires valves that have to meet particularly strict hygiene requirements, we started to develop and manufacture this kind of valve at our subsidiary in the 1990s."

Rolf Sandvoss, the grandson of Wilhelm Sandvoss and chairman of SAMSON's supervisory board from 1973 to 2001, remembers a further reason why the production was established at Lyon: "At that time, we were living in the shadow of the Cold War. Soviet tanks were located just a few hundred kilometers away from Frankfurt on the East German border. I believed it was also a matter of safeguarding the company by creating a second mainstay on the other side of the Rhine River."

Specialized production

Success at the French production site was achieved with the valve models equivalent to today's Types 3249 and 3347 Valves. They proved to be an immediate hit. These valves have a stainless steel angle-style body that can be completely drained without leaving any residual medium, allowing the valve to be thoroughly cleaned. The valve surfaces are available with an electropolished finish, making them also



well suited for particularly critical processes in the pharmaceutical and food processing industries, in which impeccable hygiene or even sterility is of utmost importance. Since 1975, SAMSON France has its own R&D team that closely cooperates with their colleagues at the Frankfurt headquarters. Besides angle valves, the French R&D team developed the Type 3310 Segmented Ball Valve, which plays an important role on the French market, as well as various other products, such as solenoid valves and supply pressure regulators. The production facilities of the French subsidiary are located in the town of Vaulx-en-Velin, just a few kilometers away from Villeurbanne and the city of Lyon. The production is not only responsible for the products sold on the French market but



Herbert Feistner (third on the right) together with heads of SAMSON subsidiaries in the 1980s

Aerial view of SAMSON S.A. in Vaulx-en-Velin taken in the 1980s



A view of the French subsidiary in Vaulx-en-Velin taken in 1999

manufactures for the entire SAMSON GROUP. Today, aseptic valves, on/off valves, segmented ball valves and various valve accessories are manufactured at this location. Rudolf Maier explains: "To draw an analogy, we are a reproduction of the Frankfurt headquarters on a scale of 10:1." Mr. Maier refers to SAMSON France's own R&D department and the specialized production, which is integrated into the global network of SAMSON's logistics. The company in Lyon supplies the supply pressure regulators and solenoid valves for instance, which are also mounted onto valve assemblies at Frankfurt.

Flexible response

Bruno Soulas, responsible for the administration including production logistics at the subsidiary, explains: "We manufacture these accessories in large quantities. However, the valves are often produced in small series. In the pharmaceutical and food processing industries, most valves are only required in small numbers to meet special specifications and certain approvals. The aver-

age order is for five to ten valves." As in the entire SAMSON GROUP, the French production facilities are able to produce tailor-made valves to meet all customer requirements down to the very last detail and tuned to the process conditions.

An almost indefinite variety of valve configurations arise from the highly diverse range of possible materials available for the body and trim, the elaborate selection and sizing of valves and the numerous end connections. The production process starts with the machining of individual components and ends with final assembly. Afterwards, all valves and instruments are thoroughly tested before they are packed and dispatched. "A well-stocked warehouse and extensive in-house manufacturing capabilities allow us to respond very quickly and flexibly to our customers' requirements," stresses Mr. Soulas.



50 YEARS of SAMSON in France

1962 Sales company SAMSON Régulation S.A. founded in Villeurbanne near Lyon

1972 Production company SAMSON S.A. founded

1974 Production started in Vaulx-en-Velin

1980 Second extension built. More than 50 members of staff working at the site

1988 Sales company SAMSON Régulation S.A. moved to Vaulx-en-Velin into the building where the production SAMSON S.A. was located

1990 Number of staff of both companies grew to 160

1995 ISO 9001 certification awarded

1998 SAMSON Régulation S.A. moved to new building in Vaulx-en-Velin

2002 PED certification (EU Directive 97/23/EC) awarded

2007 Certification according to ISO 9001 (2000) renewed

2011 SAMSON Régulation and SAMSON S.A. merged. Fourth building extension started. Number of staff rose to 250



The team at SAMSON Régulation S.A., 2012

Customer service and sales

Parallels can also be drawn when comparing sales at the French subsidiary with those at the Frankfurt headquarters: export business accounts for the majority of sales. The subsidiary in Vaulx-en-Velin not only supplies parts and accessories manufactured for SAMSON valve assemblies sold all over the globe, it is also directly involved in the export of all SAMSON products to the far corners of the globe. Countries on the export list of the subsidiary include the French overseas departments as well as numerous countries having strong historical ties with France, such as the Maghreb countries and other French-speaking regions of Africa. "We have specialists who take care of service and sales exclusively in these countries,"

Mr. Maier explains, laying emphasis on the word "and" to highlight the difference of the French subsidiary from most other SAMSON sales companies. Mr. Maier continues: "We decided in favor of deploying our staff as all-rounders. In this way, the customers have the same contact person for all matters, from the quotation stage to maintenance." 25 members of staff working in the branch offices in Paris, Marseille, Strasbourg, Roubaix-Lille, Bordeaux, Rhône-Alpes, Nantes and Caen are close at hand to advise customers. Mr. Maier emphasizes that no difference is made regarding the size of a customer: "Even a company that just orders one valve gets our full attention." Apart from this proven sales and service structure, increasingly more

importance has been placed on the cooperation with customers over the past few years. "Initially, just one member of staff was easily able to take care of project business," Mr. Maier recalls. "In the meantime, there is a whole department dealing exclusively with project work." This department primarily serves the French-based plant engineering companies who work on projects all around the globe. Mr. Maier explains: "The combination of local support and global presence, which sets SAMSON apart, is a strong asset in this area in addition to the first-rate quality of our products."

Out of Thin Air

Gases by Air Liquide



At the turn of the 20th century, the French engineer Georges Claude began experimenting to find a better way to produce pure oxygen from air. In 1902, he succeeded in developing an optimized air liquefaction process. It also gave the name to the company L'Air Liquide S.A. (French for liquid air), which George Claude founded in the very same year in Paris together with his friend Paul Delorme.

Since then, Air Liquide S.A. has focused on the production of oxygen, nitrogen, hydrogen and inert gases. Innovation is essential for the company that concentrates on developing technologies to reduce emissions and energy consumption in industrial applications, to recycle natural resources and generate sustainable energy. Around 1,000 R&D engineers work at Air Liquide's eight research centers. Alone in 2010, a total of 301 patents were registered under the company's name.

Today, the corporation is the world-leading producer of gases for industry, health and the environment. In 2011, Air Liquide recorded a sales turnover of EUR 14,457 million and employed 46,200 people in 80 countries. The company supplies customers, for example in refineries, the chemical industry, metallurgical and energy sectors. Other business activities include electronics, safety management, production process optimization, product quality enhancement and healthcare. In the field of healthcare, Air Liquide supplies medical prod-

ucts to more than 700,000 patients assisted at home as well as to over 6,000 hospitals all around the globe. The company division responsible for global engineering and construction solutions develops and builds production plants.

The gas production entails cryogenic temperatures as low as $-193\text{ }^{\circ}\text{C}$. Such extremely low temperatures places particularly high demands on materials and equipment in plants. Consequently, SAMSON developed valves for cryogenic applications and today, SAMSON rates among the technology leaders in this field. SAMSON Régulation S.A. in Vaulx-en-Velin acts as contact partner for Air Liquide all around the globe for control engineering matters.



Air Liquide is the world-leading producer of gases for industry, health and the environment

SCORING *with* TOP QUALITY

Wayne Gretzky is considered by many to be the greatest hockey player of all times in the North American National Hockey League (NHL). He celebrated his greatest triumphs in the 1980s while playing for the Edmonton Oilers. As the name indicates, the team is based in Edmonton, the capital of the Canadian province of Alberta. It is also the “oil capital” of Canada. Thanks to its oil sands, Alberta has the largest proven oil reserves after Saudi Arabia and Venezuela, and is rated as one of the world-leading natural gas producers. The capital Edmonton is the center for the national petrochemical industry. SAMSON has been operating

a service office in the northernmost North American city for many years. Recently, the new Rotary Resource Center, a competence center for rotary valves, was opened to serve the oil and gas industry where this kind of valve is used in demanding applications.

Edmonton, the capital of the Canadian province of Alberta, stretches along the North Saskatchewan River





Edmonton, the capital of valve expertise

Dave Robinson, regional manager for western Canada and head of the Rotary Resource Center explains: "There are at least 30 workshops in Edmonton alone that assemble actuators and valves. The who's who of the oil and gas sector have branch offices in the city and province. There is no better location for the Center than here." A wide variety of rotary valve types, ranging from simple ball valves to triple offset control and shut-off butterfly valves, are used in this sector. For SAMSON, these valves are supplied by companies belonging to the SAMSON GROUP, such as LEUSCH, Pfeiffer, STARLINE and VETEC, as well as the matching actuators, which are manufactured by AIR TORQUE. The initial consultation with the customer often focuses on the products supplied by these group companies.

The Rotary Resource Center serves two completely different categories of customers: Staff working for the branch office in Edmonton are directly responsible for business in Alberta. In this case, they deal directly with the valve end users and take care of all aspects of business, starting with drawing up the quotations, to sizing the valves and culminating in start-up and customer service. Besides these activities, the Center acts as the point of contact for other SAMSON sales companies located in North and South America on matters revolving around rotary valve engineering.





The ALBERTASPEC label guarantees arctic-tested quality



Regional perspective

Dave Robinson adds: "We bring together the expertise in this area and support colleagues in all matters concerning rotary valves. We act, figuratively speaking, as the link between the production departments of the companies within the SAMSON GROUP located in Europe and the sales organizations in the Americas." The compiled knowledge flows into an application database, which will eventually turn into a kind of rotary valve encyclopedia. Presently, numerous applications have already been saved in the database, providing the Center's staff with a broad basis of documented experience, for example to assist in valve sizing. Mr. Robinson explains: "Our job does not just entail selling a product. Instead, we examine each application in detail beforehand. The valves together with their accessories are sized to ensure that they are easy to handle, even under difficult conditions, and so that they function properly on a permanent basis."



STARLINE ball valves fitted with AIR TORQUE actuators safely control the flow of gas from the well head in the Horn River in northern British Columbia

Besides the continually growing virtual resources, the Center has a solid stock of hardware at its disposal. The warehouse is fully stocked with all kinds of modules suitable for rotary valves. In this way, common valves can be assembled straightaway in the workshop. Dave Robinson stresses that customary mounting parts and valve accessories from other manufacturers are stocked at the Center as well to allow the team to promptly serve customers in the region with comprehensive solutions. In addition, the Center has its own test facilities for monitoring the quality of valves before they are delivered.

ALBERTASPEC stands for top quality Cheap mass-produced products do not belong to the range on offer at the Center. A long service life and excellent reliability take top priority within the SAMSON GROUP even when it comes to the simpler valves. The Edmonton branch office has defined and created its own quality benchmark, the ALBERTASPEC label, derived from the specially high requirements of Canada's oil and gas industry. Most of the natural gas produced in the region has high carbon dioxide and hydrogen sulfide contents. As the gas production progresses increasingly further into the Arctic, plants must be able to withstand extreme temperatures in winter. Furthermore, the bore

wells are often located in extremely inaccessible regions that are difficult for service technicians to reach. Dave Robinson comments that the valves in these regions must hold out against enormous strains, yet still work properly for as long as possible. It would be easy to save a few dollars at the purchasing stage by choosing the cheapest valves. But, Mr. Robinson is convinced that the customer will eventually pay more the first time the valve malfunctions. He adds: "We are aiming for real cost efficiency with our products and consulting services. It cannot be calculated from the purchasing price, but from the costs over the entire life cycle. That's what makes our valves very competitive." To illustrate this, Dave Robinson names the trunnion ball valves by STARLINE, which are unique on the marketplace owing to their high-quality features, such

as gaskets, seats, linings and first-rate materials. The same applies to VETEC's eccentric rotary valves, which can be used for throttling service, while at the same time, have proven to act reliably as emergency shutdown components.

Mineral oil

Other products that the Center scores with in Alberta are the PTFE-lined control and shut-off butterfly valves manufactured by Pfeiffer. They are successfully used in processes to treat the oil sands. These processes involve a combination of refining and bulk processing: the oil must first be extracted from the abrasive mineral raw material

using solvents. Steam and water treatment play an important role in these processes. Mr. Robinson comments: "There are no other butterfly valves on the market that handle the high temperatures at the pressure required. These valves also provide us with very effective solutions for the mining industry and for water treatment."

The SAMSON GROUP and the Rotary Resource Center also focus on high-quality valves to serve other industrial sectors in the region. Special rotary valve constructions are used, for example in the chemical and the petrochemical industries, which operate a large number of plants in the region. An additional

benefit is the fact that the Center supplies the whole range of control valves from one source. Dave Robinson adds: "Many customers do not come to us just to buy ball valves, shut-off butterfly valves or control valves. Rather they want a complete flow control package including the associated valve components. And that is exactly what they get from us. No matter what kind of valve, we deliver top quality for all sectors."

The Rotary Resource Center supplies the complete range of control valves from a single source



ONE SINGLE GOAL

AIR TORQUE is a world-leading manufacturer of pneumatic rotary actuators for attachment to all kinds of rotary control valves.

CERA SYSTEM specializes in ball and sliding disk valves as well as pipe components with ceramic linings.

LEUSCH manufactures control and shut-off butterfly valves, ball valves and segmented ball valves. LEUSCH's core competence includes valves for pipe diameters up to three meters.

PFEIFFER provides valves for numerous industrial applications, including control, butterfly and ball valves with high-quality, homogeneous polymer linings, e.g. made of PTFE and PFA.

SAMSOMATIC produces solenoid valves and limit switches to control and monitor actuators in hazardous areas and safety-instrumented systems.

SAMSON's field of expertise covers the entire range of instrumentation and controls. SAMSON manufactures valves in all common sizes, in standard materials and exotic alloys, equipped with special linings and different actuators.

STARLINE's ball valves work at pressures above 40 bar and at high temperatures. The high-quality valves are particularly durable and certified for critical processes.

VETEC provides solutions for controlling gas, steam, liquid and solid flows. The MAXIFLUSS rotary ball valve brings together the strengths of control valves, butterfly valves and ball valves.



Prompt Support for Customers in Africa

In past times, it took at least one week to just send a defective positioner from South Africa to Frankfurt and back again. These days, the entire repair work can be completed at the South African subsidiary in Cape Town within one day. Its service and test center for positioners is unique within the entire African instrumentation and controls market. The center serves customers on the African continent and provides fast after-sales support as well as testing and certification services. As a result, the repaired instruments can also be installed in hazardous areas again.

Bob Breytenbach, head of the service and test center on the Cape of Good Hope, explains: "The compressed air supply is almost always the problem when a SAMSON positioner stops working. The instrument air contains too much water, even oil sometimes, usually because an air drying station is not working properly. The water then condenses in the positioner and eventually puts it out of action." Such a defect can easily be remedied in less than two hours. The South African after-sales service staff deal with urgent repair work immediately. Companies in the region can often re-install their positioners on the very same day.

Standardized concept

"We also help our customers to remove the root cause and, if necessary, install a filter or demister upstream of the positioner," says Mr. Breytenbach and gives an insight into his experiences in service work that has seen him and his colleagues travel to many countries south of the Sahara.

Whenever the service technicians are away on a service assignment, the sales engineers in the office are called in to take their place when urgent repairs are needed. The engineers receive the same comprehensive training. They can count on a standardized routine: the service and test center in Cape Town is identical to its counterpart in Frankfurt right down to how the spare part containers are arranged. "The only thing that is different is that I've positioned

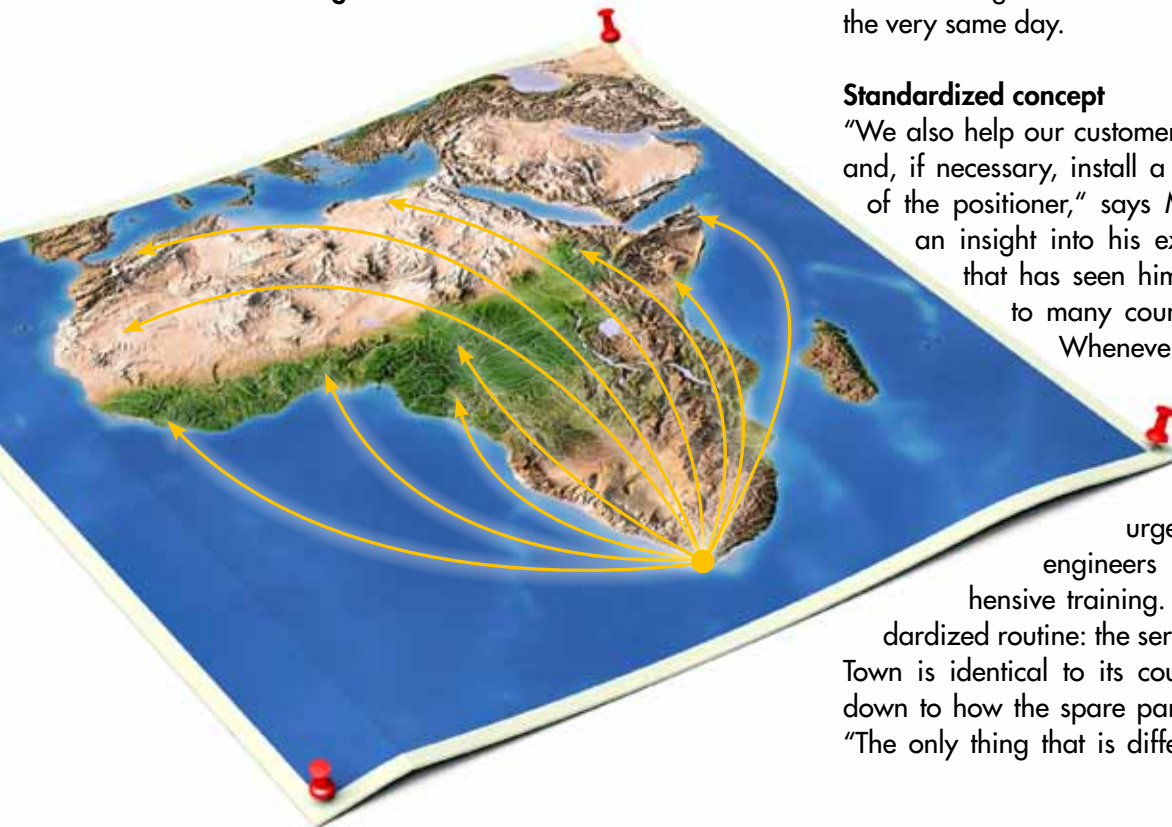



my computer screen a bit lower to allow me to see the screen better with my varifocal glasses," explains the service manager.

Three years ago, the subsidiary in Cape Town took on the leading role in reproducing the service center concept used at Frankfurt. "Southern Africa is not only geographically a long way from Central Europe. The obstacles to get shipments through customs or to obtain visas and vaccination certificates are far more difficult to overcome than in other regions," observes Jochen Gräff, head of the South African SAMSON subsidiary. "It was imperative for us to have these service facilities in our own country to allow us to serve our customers promptly."

Diagnostics and certification

Meanwhile, other SAMSON subsidiaries have set up identical service and test centers. An additional feature that these subsidiaries have in common with the centers in Cape Town and Frankfurt is the extensive quality check performed after every positioner repair. All the necessary diagnostic tests are performed on the test bench. A calibration protocol is made, the positioner is assigned a repair ID and a certification stamp is affixed to it. This allows explosion-protected positioners to be reinstalled in hazardous areas. "After pressing the enter key, the relevant data are also automatically transmitted to a server at the Frankfurt headquarters. This means the repair work is fully documented and can be traced back to the last detail. In this way, SAMSON provides its African customers with fast service and a high level of reliability," concludes Mr. Gräff.



Positioners undergo extensive quality checks at the SAMSON service and test center in Cape Town

Jochen Gräff (left in the front row) together with his team at SAMSON CONTROLS PYT LTD. in Cape Town

Unity Through Design



The new SAMSON exhibition stand at ACHEMA 2012 was characterized by a clear and straightforward design and benefits from modern IT equipment. The new look is in keeping with the SAMSON GROUP's endeavor to provide customers with comprehensive and advanced process automation solutions. The almost limitless variety of product options was presented on large touch screens. Visitors to the stand had the opportunity to configure their own *virtual* valve on screen and to vary the valve configuration in any way

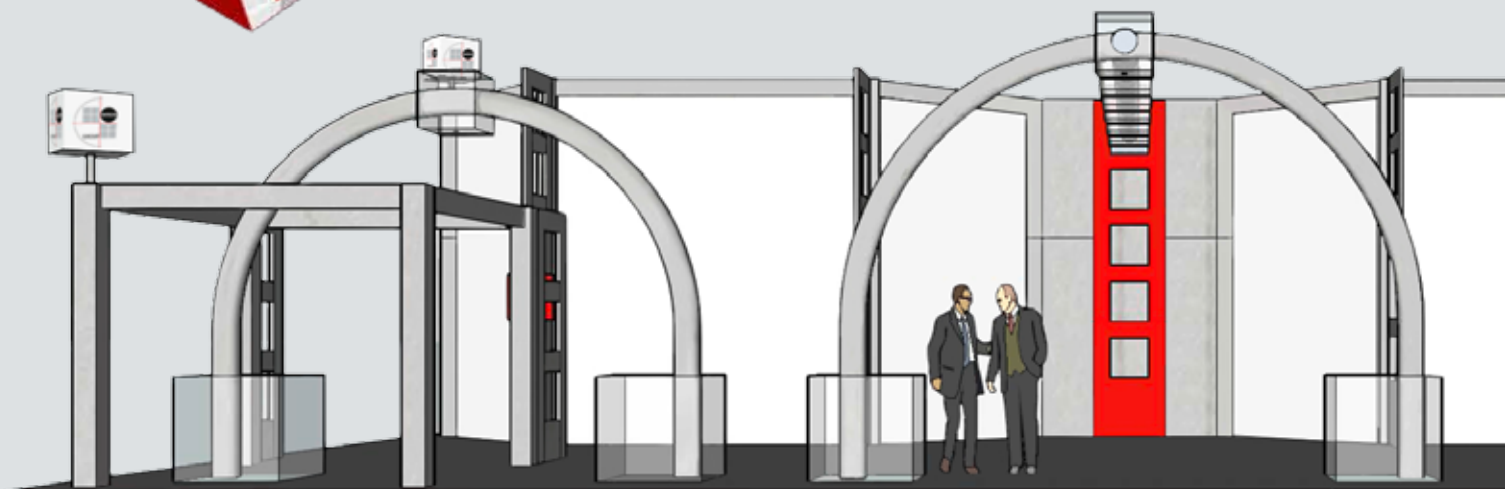



SAMSON

worldwide

GROUP

they wanted. New design elements including cubes, squares and arches symbolize the corporate concept within the SAMSON GROUP. They emphasize the abundance of options and flow of synergies arising from the cooperation between the highly specialized companies within the group. Mr. Markus Güntner, stand manager and responsible for control valve sales at SAMSON, explained the connection between the corporate image and inner essence of the group during an interview at the ACHEMA fair.

The new SAMSON exhibition stand concept is characterized by a clear and straightforward design and benefits from modern IT equipment

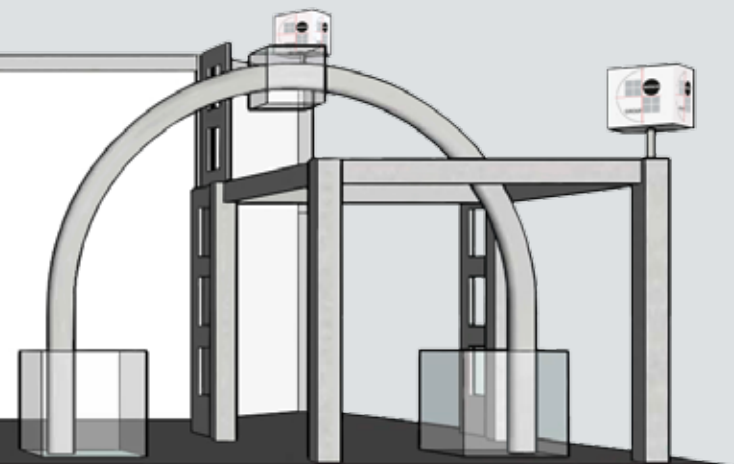

SAMSON has redesigned its corporate image, not only at the fair. Has just a new design been created or is there more to it than that?

It would be mere pretence if outward appearances did not mirror the inner values of a company. But there's no question about it in our case: SAMSON is a very dynamic company. The newly designed corporate image expresses the developments and changes that we have undergone over the past few years.

What changes come to mind first and foremost?

The motto at SAMSON is 'Where innovation is tradition'. This sums up the success story that we have written over the past 100 years and more. We have profited from our exceptional expertise right from the start, which allowed us to continuously develop our proven technologies as well as integrate new technologies based on sound groundwork for the benefit of our customers. Digitalization, communication features, remote access and predictive maintenance are just a few of the topical matters on the agenda. That's why there is less hardware on show at the stand. We want to concentrate more on the virtual display of the countless options that we have available for our customers.

Why has the stand grown in size?

SAMSON has grown and we want to continue to grow as in the past: organically and at a healthy pace. A fitting allegory for this is the new building that is currently being constructed at our Frankfurt headquarters. It will house a CNC machining center able to handle valves up to three meters in diameter, allowing us to machine very large valves in-house in the future. We are the

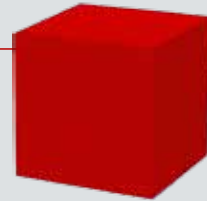

global leader in control valves for the chemical industry, the main industry targeted at AICHEMA. We have also worked hard to establish ourselves well on many other markets. At the same time, we still see great potential for growth in many other sectors, such as oil and gas. Meanwhile we have reached a size that makes us a global player in process automation. This also brings new challenges.

For example?

Transparency is the keyword that immediately comes to mind. More and more customers need more accurate information on how their order is progressing. To provide such transparency, we need to rethink and reorganize some business areas within the company. This is mirrored in the open layout of our exhibition stand, which includes transparent design elements. We have also redesigned our website, which we are continuously extending to offer customers a greater depth of information. But we don't just react to specific requests. We also try to anticipate the future needs of our customers.

What ambitions does SAMSON have for the future?

We have established teams in various areas of the company to take a completely fresh approach on corporate processes and see how and where we can improve them further. For instance, how do customers rate their business with SAMSON? Where are things not running so smoothly? Could some processes run better and more efficiently? Where could we perhaps do more to improve the customers' processes? Initially, most of the team members found it unusual to start off without any specific definition of the task at hand. But, eventually, this open approach very quickly inspired the team's creativity. We have obtained a great deal of information from the teams about existing processes as well as many new ideas and clear priorities for further improvement.

The new SAMSON exhibition stand at AICHEMA 2012 attracted many visitors





Do the arches and squares around the stand signify anything in particular?

Both style elements appear in our new group logo and have symbolic character. The squares stand for the other members of the SAMSON GROUP: AIR TORQUE, CERA SYSTEM, KT-Elektronik, LEUSCH, PFEIFFER, STARLINE, SAMSOMATIC and VETEC. Even though they belong to the SAMSON GROUP, they still are to be regarded as individual companies in their own right. In the group logo, arches form a bridge between these squares. The arches have been extended on the stand to symbolize pipes. Our intention in doing this was to highlight the common feeling of unity within the group, even more so than in the past.

That sounds somewhat contradictory.

It is a balancing act. Many companies in a similar setup focus upon incorporating the acquired companies until they are fully absorbed by the parent company. We have consciously chosen not to go down this path right from the beginning. Instead, we lay emphasis on the independence of the individual companies within the group. Each company has its own specialized engineering competence and its own access to markets. We still believe that these strengths thrive better when a company and brand remain as they originally were. To date, the shared identity of the companies within the SAMSON GROUP has not been very evident to outsiders. That is about to change though.

What message do you want to convey to your customers?

Our intention is to show our customers that we, the SAMSON GROUP, are able to provide them with comprehensive solutions. Owing to the various specializations of the individual companies within the group, we master almost all types of control valves to the highest standard. Consequently, we have a suitable high-quality solution for every control task.

Why are some of the group companies exhibiting on their own stands at the AICHEMFAIR?

As I have already said, the individual companies within the group have kept their independence. But, they are highlighting at AICHEMFAIR that they are part of the SAMSON GROUP. There are also practical reasons why they are exhibiting on their own stands, for example due to long-term contracts with the fairground organization. If nothing else, we can demonstrate our core competence twice over and provide our customers with double access to our services: SAMSON is sharing its stand with SAMSOMATIC and VETEC in Hall 11, in which the main focus is on higher-level process automation. The other group companies are located in Hall 8, traditionally the location for valve manufacturers. We will be exhibiting on a common stand at the Valve World Expo in November 2012 and at this year's NAMUR annual general meeting, of which we are the main sponsor.



SAMSON presented the almost limitless variety of product options on large touch screens

Experienced SAMSON staff demonstrated the numerous functions of our valves and actuators to visitors





OXYGEN: TACKLING A BURNING ISSUE

Technically speaking, oxygen itself does not burn, yet it plays a part in every combustion process, from the log fire warming our home to the fuel vapor combusted in the cylinder head to drive our cars. The wood as well as the fuel react with the oxygen gas and release energy. When speaking of an “oxygen fire”, which is wrong in itself, we refer to burning things that are usually considered non-flammable, such as metals. However, the risk of fire increases the higher the pressure, temperature and oxygen concentration in the environment are. Take a steel mill, for example: Here, pure oxygen at high pressure is blown into a melt that is hotter than 1000 °C. This means that the piping and valves used must be resistant to oxygen fires. SAMSON manufactures tailor-made valves that work safely and reliably under such severe operating conditions. Recently, SMS Siemag AG fitted several steel mills in India with our valves.

India, the steel giant

Indian companies play an important role on the world-wide steel market: ArcelorMittal, Jindal Steel, Tata Steel and Bhushan Steel figure among the top players in the industry. In 2011, India ranked fourth among the world’s biggest crude steel producers, which makes it an important market for SMS Siemag. The company with over 11,000 employees specializes in plant and mechanical engineering for the steel, aluminum and nonferrous metal industry. The range of services provided includes turnkey production plants as well as plant expansions and upgrading.

SMS Siemag received several orders from India in 2010 and 2011. For example, the Rourkela mill, which belongs to the state-run Steel Authority of India, as well as works operated by Bhushan Steel and Tata Steel were to be equipped with new converters. Converters are the massive ladles where molten raw iron, which is rich in

carbon, is converted into low-carbon steel. The decisive step in this conversion is cleansing out impurities, such as carbon, silicon, manganese, sulfur and phosphorus, which are removed from the 1700-°C-hot molten raw iron by oxidation.

Igniting impurities

Burning the unwanted ingredients generates so much heat that the converters do not need to be heated from the outside to keep the raw

iron molten. What is needed though is oxygen in abundance. It is blown into the converter from the top through a water-cooled pipe with a nozzle, the lance. The incoming oxygen creates a violent exothermic reaction that burns the impurities and also creates turbulence to mix the melt.

Mr. Frank Baltes, who coordinated the SMS Siemag order for India from our SAMSON office at Krefeld, Germany, knows what it comes down to: "The exact timing and dosage of the blown-in oxygen are crucial. In the process, pure oxygen at a high pressure is handled. Under such conditions, the impact of a small dirt particle can suffice to create a spark and ignite the metal equipment." This risk is particularly high

in the valve, where the gas flow is deflected and subjected to mechanical influence.

Finding the right alloy

There is not one single metal that is resistant to oxygen fire. Nevertheless, different metals and alloys show varying degrees of ignition susceptibility. Mr. Baltes describes the challenge involved in material selection as follows: "We need to find the right material and wall thickness - taking into account a sufficient safety margin - to prevent an ignition even under the most unfavorable of conditions. We calculated several sizing alternatives to match the special requirements. Finally, the customer decided in favor of a Type 3241 Valve with a stainless

The iron ores are reduced in a blast furnace. The carbon-rich molten raw iron is converted into low-carbon steel in massive converter ladles



steel body and a seat and plug trim made of Monel®." Monel is an alloy that contains approximately 65 % of nickel, 33 % of copper and 2 % of iron. It is characterized by a high tensile strength and, more importantly in this case, a very high resistance to oxygen.

Cooperation of steel

Mr. Baltes recollects how information was exchanged back and forth with the customer during the planning stage: "We provided the plans as 3-D volume models so that everything would fit perfectly together once it was completed and the strict safety regulations could be met." Despite the intense planning, a small accident involving a forklift happened when the valves were unloaded in India. The resulting damage, however, could be remedied immediately by SAMSON's Indian after-sales service staff. This minor incident has not stopped the valves from working as planned and specified by the customer ever since.

When working with plant engineering companies like SMS Siemag, which operate all across the world, it is a

clear advantage if a supplier can also rely on a world-wide network to ensure that spare parts and service personnel are readily available. "Our cooperation with SMS Siemag has been going on for years. Our expertise in special materials and exotic alloys is of great importance to this customer and we have been able to score points by showing great flexibility in handling quotations and orders," summarizes Mr. Baltes. And he states another factor that played into SAMSON's hands in this order: "our experience gained as a supplier to all major producers of technical gases."

SMS Siemag, a specialist in international plant engineering, recently equipped several steel mills in India with tailor-made control valves manufactured by SAMSON



SAMSON CONTROLS PVT. LTD.

SAMSON has been active in India for more than 25 years and opened a subsidiary there in 1999. In 2009, the company headquarters were moved from the metropolis of Mumbai to Ranjangaon in the state of Maharashtra. The SAMSON site is situated in a newly created industrial park that offers sufficient space for future expansion. Its location was chosen strategically: between the industrial centers of Pune to the southwest and Aurangabad to the northeast. Pune is the heart of the Indian automotive industry and an educational center with numerous universities, colleges and other institutions. Many international engineering companies have set up their local headquarters there. Aurang-

abad has attracted a wide variety of companies active in the processing industries.

In 2011, SAMSON India opened a production site at Ranjangaon, where valves, positioners, self-operated regulators for pressure, differential pressure and temperature as well as differential pressure meters are manufactured. The investment made amounted to approximately EUR 3.5 million to serve the expanding Indian market. Apart from the Ranjangaon headquarters, SAMSON has branch offices in Bangalore, Baroda, Chennai, Delhi, Kolkata, Mumbai, Hyderabad and Pune to provide our customers all across India with the quick and reliable SAMSON on-site service that we are known for. SAMSON India has more than 120 members of staff. Customers serviced include BASF, Evonik, GEA, INOX, Linde, Lurgi, Uhde, IOCL, Tetra Pak, BHEL, PRAJ and Thermax



Inauguration of the new facilities at Ranjangaon (from left to right: Gerhard Schäfer, Atul Rajee (Head of SAMSON CONTROLS PVT. LTD.), Ludwig Wiesner (Chairman of the SAMSON AG Executive Board), Dr. Leopold-Theodor Heldmann (Consul General of Germany in Mumbai), Hans-Erich Grimm (Vice Chairman of SAMSON AG), Uwe Vogel

A REWARDING YEAR

The Eurozone crisis has cast its ugly shadow over the European Union and even made its presence felt in the member states. So far, however, it has been unable to significantly affect the progress of the process industry even though the first signs indicate that the global economy is slowing down and investment activities are slackening off. It is against this background that SAMSON looks back on a rewarding financial year and sturdy growth. The consolidated group sales increased by 4.4 % to EUR 532 million. Naturally, the development of our business in the various regions and sectors has varied.

Export at SAMSON has always played an important role right from the early days. A few years after the company was founded, sales representatives sold SAMSON products in France, the UK and Switzerland. These were also the first countries in which the first factory branches and subsidiaries were opened. They can look back on more than 50 years' history since their foundation: the UK subsidiary in 1958 and the French subsidiary in 1962. SAMSON subsidiaries were also founded early on in the emerging economies of the BRIC countries, which today constitute 17 % of consolidated group sales. The subsidiary in India was founded in 1991, Brazil in 1997 and China and Russia followed in 1998.

Western Europe remained the top sales region, recording a 5.8 % sales increase. The export-oriented plant construction and mechanical engineering sectors contributed extensively to this positive development. In Eastern Europe, business in particular in the subsidiaries in Poland, Romania and Hungary developed positively with a double-digit increase. In Russia, last year's figures could not be topped since a project for a large-scale refinery caused an extraordinary peak in sales in the 2010/2011 financial year.

Asia contributed the second-largest share to SAMSON's worldwide sales after Western Europe with a 10.1 % sales increase. Ten subsidiaries and three service centers with over 430 employees represent SAMSON in Asia. SAMSON China is the second-most important market for SAMSON GROUP after Germany. The subsidiary in China increased its sales by 6.8 % in the 2011/2012 financial year.

SAMSON was able to increase sales in the Americas as well. The subsidiaries in the NAFTA zone recorded a 5.6 % increase. The five South American subsidiaries in Argentina, Brazil, Chile, Peru and Venezuela also developed satisfactorily, recording a sales plus of 28.2 %.



The chemical industry figures among the most important sectors for SAMSON's products. A study carried out by a renowned North American marketing research institute designates SAMSON a world leader for control valves in this sector with a worldwide market share of 13.4 %.

Business in the oil and gas sector is particularly dynamic. We were able to continue to increase our market share in offshore applications in Norway. Particularly rugged and reliable devices are needed for the specially equipped tankers known as FPSO (Floating Production, Storage and Offloading) vessels and FSRUs (Floating Storage Regasification Units). The high-quality valves made by SAMSON are perfectly suited for these jobs. The same applies to the installation on conventional oil platforms. Thanks to the business transactions at our spe-

cialist engineering office in Houston, SAMSON valves can be found on an increasing number of oil platforms. The Canadian subsidiary benefits from the booming market to exploit the gas and oil fields in the province of Alberta. SAMSON Canada has worked hard to gain a strong position in this sector by keeping delivery times short and offering valves specially developed for these applications, e.g. the Type 3525 Compact Valve. The new Rotary Resource Center at Edmonton plays an important role for this market sector.

SAMSON has also made a great deal of progress in the alternative energy generation sector. To date, over 2,000 SAMSON control valves run in solar thermal power stations in Spain. In the current financial year, SAMSON won an order with a total value of over one million US dollar for a solar project in the Sonora desert in California. In the US state of Tennessee, a work, in which control valves made by the SAMSON GROUP are installed, is being built to produce polycrystalline silicon for photovoltaic solar cells.

Alternative energy sources, such as biomass (10 %) and hydropower (2 %), however, still only make a small contribution to satisfying the enormous global demand for energy. Consequently, SAMSON backs the systematic further development of our technology to save energy in the district heating and cooling sectors. A definite orientation towards this market is demonstrated by the opening of a new sales office (V156) for international district energies. This office relies on the long years' experience that SAMSON has gathered in this sector in Germany, the Netherlands, Austria and Poland. This expertise is to be used in the emerging markets, for example in China, Russia and in the Middle East. In particular, district cooling opens new business opportunities in Europe and in the Gulf region, for example. SAMSON instruments have already been proven in use in district cooling plants in the megacities of Tokyo and Osaka.

Financial year 2011/2012

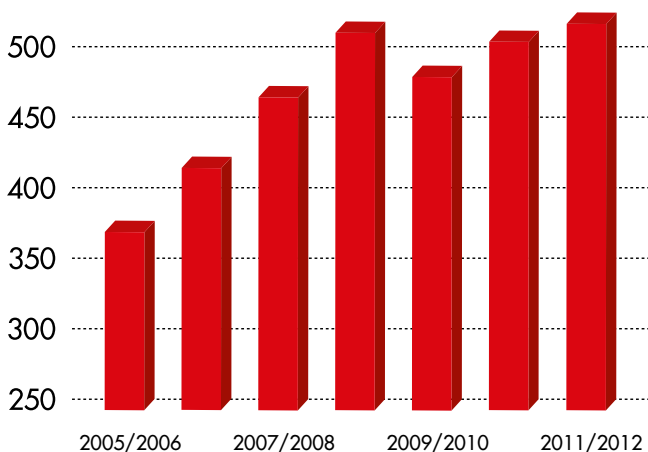

Net sales in million euro

New subsidiary in Vietnam

In May 2011, SAMSON opened a new subsidiary in Vietnam to strengthen SAMSON's footing in the emerging South Asian market. SAMSON already has subsidiaries in this region, for example in Malaysia, Thailand, Singapore and the Philippines. On the eighth floor of an office complex in Ho Chi Minh City, a team of six employees takes care of Vietnamese customers. Mr. Huy Phuong Nguyen, head of the subsidiary, manages his team, which is made up of experts for sales, marketing and finance as well as two engineers responsible for sales and customer service. Major customers include the renowned food and beverage corporation, Nestlé and Wilmar International Limited, one of Asia's leading agribusinesses. Several large breweries, such as Vietnam Brewery Limited (VBL) and Hanoi Beer Company (Habeco), are also customers. Customers include PetroVietnam Technical Services Corporation (PTSC) and VIETSOVPETRO in the oil and gas sector as well as other companies, such as P&G, Vietnam Tobacco and Holcim.



Huy Phuong Nguyen (right) and his team at SAMSON VIETNAM CO., LTD.

CERA SYSTEM®

✓ more than ceramics

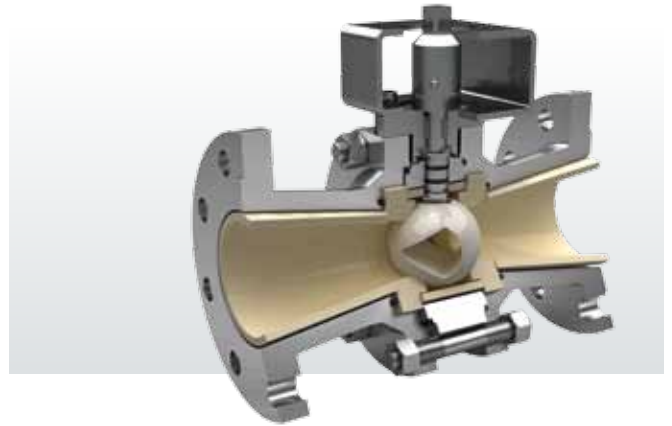

CERA SYSTEM products enhance the portfolio of the SAMSON GROUP to include ceramic-lined ball and slide valves as well as pipe components

CERA SYSTEM joins the SAMSON GROUP

Modern high-tech ceramics achieve a degree of hardness that is only surpassed by diamonds. These materials are exceptionally wear-resistant, while at the same time possessing excellent sliding properties. This makes them perfectly suited in many applications in which mechanical friction cannot be avoided. Ceramic linings and parts subject to wear play an important role in SAMSON's product range as a result. Since 1 January 2012, this also applies to the development and production of ceramic components: the ceramic specialist CERA SYSTEM Verschleißschutz GmbH based in Hermsdorf, Germany became a member of the SAMSON GROUP at the beginning of 2012. The acquisition supplements the SAMSON product range to include ceramic-lined ball and slide valves as well as pipe components with ceramic linings for applications involving abrasive and corrosive media. CERA SYSTEM develops and manufactures valves for the most severe operating conditions as well as high-precision ceramic parts for different industries as an OEM. "With the acquisition of CERA SYSTEM, we have enhanced our portfolio and further extended our control valve expertise," announced Ludwig Wiesner, Chairman of the SAMSON AG Executive Board.

New factory building at AIR TORQUE and STARLINE in Bergamo

In summer 2011, the companies AIR TORQUE and STARLINE, members of the SAMSON GROUP, moved into new facilities built at their site in Bergamo, Italy. As a result, their premises have increased by more than half. The total area of the premises covers 28,000 m², including green space and loading zones. Three buildings are located on site that accommodate the production with an area of 15,000 m² as well 3,000 m² of office space. The new facilities come along with improved logistics, the introduction of a modern ERP system and improved synergy effects, for example by sharing material management and



the same reception area. As a result, the processes within both companies have been optimized and made more efficient. Two new production lines at AIR TORQUE have increased its production capacity by 30%. The increased capacities allow the companies to respond more flexibly to the increased demand for pneumatic rotary actuators and forged ball valves.

Production in the new building at Bergamo



This year, the SAMSON GROUP's European Sales Meeting was held at AIR TORQUE and STARLINE in Bergamo.



SAMSON AG · MESS- UND REGELTECHNIK
Weismüllerstraße 3 · 60314 Frankfurt am Main · Germany
Phone: +49 69 4009-0 · Fax: +49 69 4009-1507
E-mail: samson@samson.de · Internet: www.samson.de
SAMSON GROUP · www.samsongroup.net